

SNA1G08 Single 2-Input Positive-AND Gate

Features

- Operating Voltage Range: 1.65V to 5.5V
- Low Power Consumption: 1μA (Max)
- Operating Temperature Range: -40°C to +125°C
- Inputs Accept Voltage to 5.5V
- High Output Drive: ±24mA at $V_{CC}=3.0V$
- Packages: SOT23-5, SC70-5

Applications

- Active Noise Elimination
- Bar Code Scanner
- Blood Pressure Monitor
- CPAP Machine
- Fingerprint identification
- Network attached storage (NAS)

General Description

The SNA1G08 Single 2-input positive-AND gate is designed for 1.65V to 5.5V V_{CC} operation.

The SNA1G08 device performs the Boolean function $Y=A \cdot B$ or $Y= \overline{\overline{A} + \overline{B}}$ in positive logic. The device is fully specified for partial-power-down applications using Ioff. The Ioff circuitry disables the outputs, preventing damaging current backflow through the device when it is powered down.

Simplified Schematic

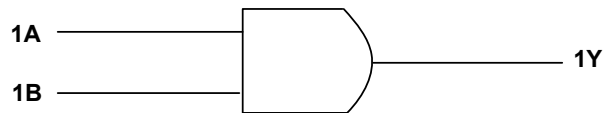

Ordering Information

Part Number	V_{OUT} (V)	Package	Ordering Number	Packing Option
SNA1G08	XX ^[1]	SOT23-5	SNA1G08Q00CB5	Tape and Reel, 3000
SNA1G08	XX	SC70-5	SNA1G08Q00CE5	Tape and Reel, 3000

[1] XX indicates 0.8V~5.0V. For example, 33 means product outputs 3.3V.

Function Table

Inputs		Output
A	B	Y
H	H	H
L	H	L
H	L	L
L	L	L

$Y=A \cdot B$, H=HIGH Logic Level, L=LOW Logic Level.

Contents

1	Pin Description	3
2	Specifications	4
2.1	Absolute Maximum Ratings.....	4
2.2	ESD Ratings.....	4
2.3	Thermal Information.....	4
2.4	Recommanded Operating Range.....	5
2.5	Electrical Characteristics.....	5
2.6	Switching Characteristics.....	6
3	Parameter Measurement Information	7
4	Package Outline	8
5	Revision History	10

1 Pin Description

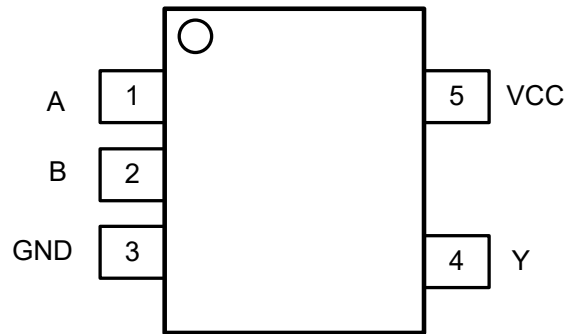

SOT23-5/SC70-5

Pin	Name	I/O TYPE	Function
SOT23-5/SC70-5			
1	A	I	A input
2	B	I	B input
3	GND	P	Ground pin
4	Y	O	Y output
5	VCC	P	Power pin

2 Specifications

2.1 Absolute Maximum Ratings

Over operating ambient temperature range (unless otherwise noted) ^{[1][2]}.

Parameter	Symbol	Min	Max	Unit
Supply voltage range	V_{CC}	-0.5	6.5	V
Input voltage range ^[2]	V_I	-0.5	6.5	V
Voltage range applied to any output in the high-impedance or power-off state ^[2]	V_O	-0.5	6.5	V
Voltage range applied to any output in the high or low state ^{[2][3]}	V_O	-0.5	$V_{CC}+0.5$	V
Input clamp current	$V_I < 0$	I_{IK}	-50	mA
Output clamp current	$V_O < 0$	I_{OK}	-50	mA
Continuous output current	I_O		±50	mA
Continuous current through V_{CC} or GND			±100	mA
Junction Temperature	T_J	-65	150	°C
Storage Temperature Range	T_{STG}	-65	150	°C

Note:

[1] Stresses greater than those listed under "Absolute Maximum Ratings" may cause permanent damage to the device. These are stress ratings only, and functional operation of the device at these or any other conditions beyond those indicated under "Recommended Operating Conditions" is not implied. Exposure to "Absolute Maximum Ratings" for extended periods may affect device reliability;

[2] The input and output negative-voltage ratings may be exceeded if the input and output current ratings are observed.

[3] The value of V_{CC} is provided in the Recommended Operating Conditions table.

2.2 ESD Ratings

Parameter	Symbol	Value	Unit
Electrostatic discharge	V_{ESD}	Human-body model (HBM)	±8000
		Machine model (MM)	±500

2.3 Thermal Information

Thermal Metric	Symbol	SOP23-5	SC70-5	Unit
Junction-to-ambient thermal resistance	$R_{\theta JA}$	273.8	214.7	°C/W
Junction-to-case (top) thermal resistance	$R_{\theta JC(top)}$	126.8	127.1	°C/W
Junction-to-board thermal resistance	$R_{\theta JB}$	85.9	60.0	°C/W
Junction-to-top characterization parameter	ψ_{JT}	10.9	33.4	°C/W
Junction-to-board characterization parameter	ψ_{JB}	84.9	59.8	°C/W
Junction-to-case (bottom) thermal resistance	$R_{\theta JC(bot)}$	N/A	N/A	°C/W

2.4 Recommended Operating Range

Over operating ambient temperature range (unless otherwise noted).

Parameter	Symbol	Conditions	Min	Max	Unit
Supply voltage	V_{CC}	Operating	1.65	5.5	V
		Data retention only	1.5	5.5	
High-level input voltage	V_{IH}	$V_{CC}=1.65V$ to $1.95V$	$0.65 \times V_{CC}$		V
		$V_{CC}=2.3V$ to $2.7V$	1.7		
		$V_{CC}=3V$ to $3.6V$	2.2		
		$V_{CC}=4.5V$ to $5.5V$	$0.7 \times V_{CC}$		
Low-level input voltage	V_{IL}	$V_{CC}=1.65V$ to $1.95V$		$0.15 \times V_{CC}$	V
		$V_{CC}=2.3V$ to $2.7V$		0.3	
		$V_{CC}=3V$ to $3.6V$		0.4	
		$V_{CC}=4.5V$ to $5.5V$		$0.15 \times V_{CC}$	
Input voltage	V_I		0	5.5	V
Output voltage	V_O		0	V_{CC}	V
Input transition rise or fall	t_r, t_f	$V_{CC}=1.8V \pm 0.15V, 2.5V \pm 0.2V$		20	ns/V
		$V_{CC}=3.3V \pm 0.3V$		10	
		$V_{CC}=5V \pm 0.5V$		5	
Operating temperature	T_A		-40	+125	°C

2.5 Electrical Characteristics

Parameter	Conditions	Temp	Min	Typ	Max	Unit	
V_{OH}	$I_{OH}=-100\mu A, V_{CC}=1.65V$ to $5.5V$	Full	$V_{CC}-0.1$			V	
	$I_{OH}=-4mA, V_{CC}=1.65V$		1.2				
	$I_{OH}=-8mA, V_{CC}=2.3V$		1.9				
	$I_{OH}=-16mA, V_{CC}=3V$		2.4				
	$I_{OH}=-24mA, V_{CC}=3V$		2.3				
	$I_{OH}=-32mA, V_{CC}=4.5V$		3.8				
V_{OL}	$I_{OL}=100\mu A, V_{CC}=1.65V$ to $5.5V$	Full			0.1	V	
	$I_{OL}=4mA, V_{CC}=1.65V$				0.45		
	$I_{OH}=8mA, V_{CC}=2.3V$				0.3		
	$I_{OH}=16mA, V_{CC}=3V$				0.4		
	$I_{OH}=24mA, V_{CC}=3V$				0.55		
	$I_{OH}=32mA, V_{CC}=4.5V$				0.55		
I_i	A or B inputs	$V_I=5.5V$ or GND, $V_{CC}=0V$ to $5.5V$	+25°C		± 0.1	± 1	μA
		Full			± 5		
I_{off}	V_I or $V_O=5.5V, V_{CC}=0V$	+25°C		± 0.1	± 1	μA	
		Full			± 10		
I_{CC}	$V_I=5.5V$ or GND, $I_O=0, V_{CC}=1.65V$ to $5.5V$	+25°C		0.1	1	μA	
		Full			10		
ΔI_{CC}	One input at $V_{CC}-0.6V$, Other inputs at V_{CC} or GND, $V_{CC}=1.65V$ to $5.5V$	Full			500	μA	

2.6 Switching Characteristics

Over recommended operating free-air temperature range (-40°C to 125°C, unless otherwise noted.)

Parameter	Symbol	Conditions		Min	Typ	Max	Unit
Propagation Delay	t_{pd}	$V_{CC}=1.8V\pm 0.15V$	$C_L=30pF, R_L=1k\Omega$		11.6		ns
		$V_{CC}=2.5V\pm 0.2V$	$C_L=30pF, R_L=500\Omega$		6.6		ns
		$V_{CC}=3.3V\pm 0.3V$	$C_L=50pF, R_L=500\Omega$		5.4		ns
		$V_{CC}=5V\pm 0.5V$	$C_L=50pF, R_L=500\Omega$		4.3		ns
Input Capacitance	C_i	$V_{CC}=0V$			4		pF
Power dissipation capacitance	C_{pd}	$V_{CC}=3.3V$	$f=10MHz$		26		pF
		$V_{CC}=5V$			31		pF

 **Note:** All unused inputs of the device must be held at V_{CC} or GND to ensure proper device operation.

3 Parameter Measurement Information

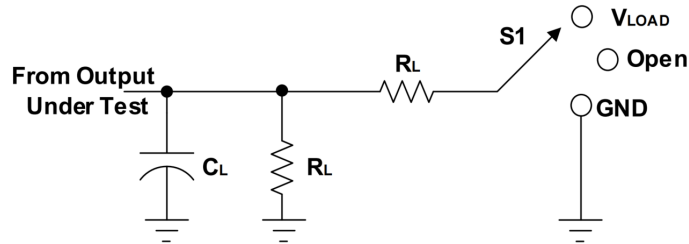

TEST	S1
t_{PLH}/t_{PHL}	Open
t_{PLZ}/t_{PZL}	V_{LOAD}
t_{PHZ}/t_{PZH}	GND

V_{CC}	INPUTS		V_M	V_{LOAD}	C_L		R_L		V_{Δ}
	V_I	T_r/T_f							
1.8V±0.15V	V_{CC}	≤2ns	$V_{CC}/2$	2 X V_{CC}	15pF	30pF	1MΩ	1kΩ	0.15V
2.5V±0.2V	V_{CC}	≤2ns	$V_{CC}/2$	2 X V_{CC}	15pF	30pF	1MΩ	500Ω	0.15V
3.3V±0.3V	3V	≤2.5ns	1.5V	6V	15pF	50pF	1MΩ	500Ω	0.3V
5V±0.5V	V_{CC}	≤2.5ns	$V_{CC}/2$	2 X V_{CC}	15pF	50pF	1MΩ	500Ω	0.3V

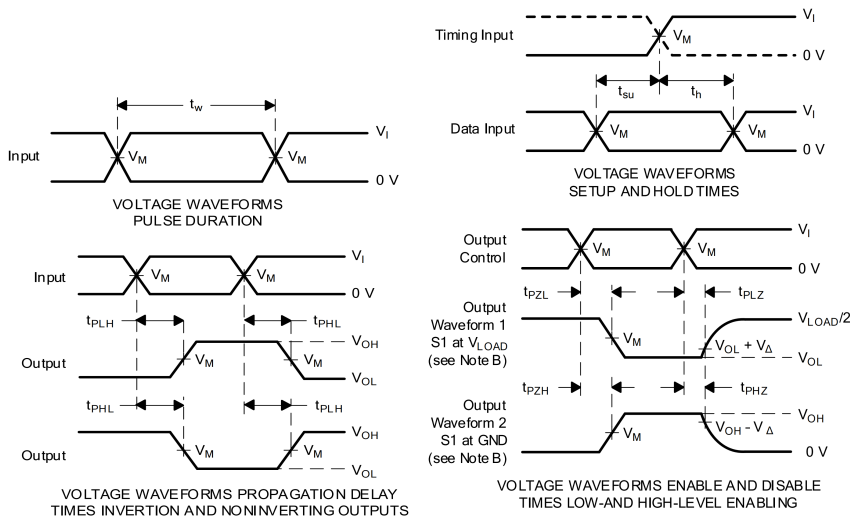

Note:

- [1] C_L includes probe and jig capacitance.
- [2] Waveform 1 is for an output with internal conditions such that the output is low, except when disabled by the output control.
Waveform 2 is for an output with internal conditions such that the output is high, except when disabled by the output control.
- [3] All input pulses are supplied by generators having the following characteristics: PRR ≤ 10 MHz, $Z_0 = 50\Omega$.
- [4] The outputs are measured one at a time, with one transition per measurement.
- [5] t_{PLZ} and t_{PHZ} are the same as t_{dis} .
- [6] t_{PZL} and t_{PZH} are the same as t_{en} .
- [7] t_{PLH} and t_{PHL} are the same as t_{pd} .
- [8] All parameters and waveforms are not applicable to all devices.

4 Package Outline

4.1 SOT23-5

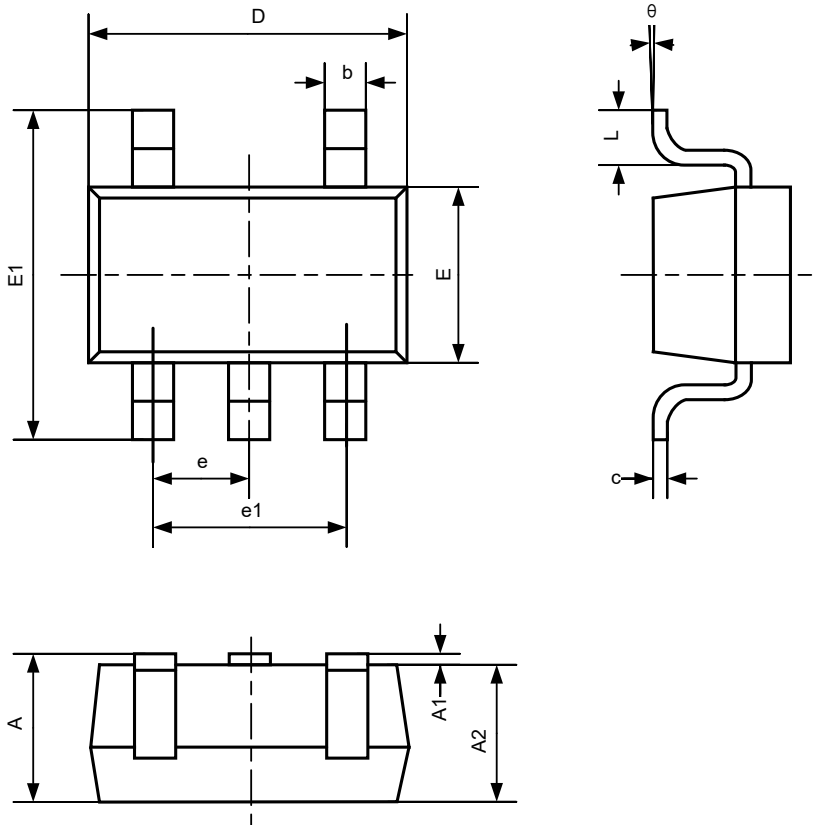

Symbol	Dimensions in Millimeters		Dimensions in Inches	
	Min	Max	Min	Max
A	1.050	1.250	0.041	0.049
A1	0.000	0.100	0.000	0.004
A2	1.050	1.150	0.041	0.045
b	0.300	0.500	0.012	0.020
c	0.100	0.200	0.004	0.008
D	2.820	3.020	0.111	0.119
E	1.500	1.700	0.059	0.067
E1	2.650	2.950	0.104	0.116
e	0.950 BSC		0.037 BSC	
e1	1.900 BSC		0.075 BSC	
L	0.300	0.600	0.012	0.024
θ	0°	8°	0°	8°

4.2 SC70-5

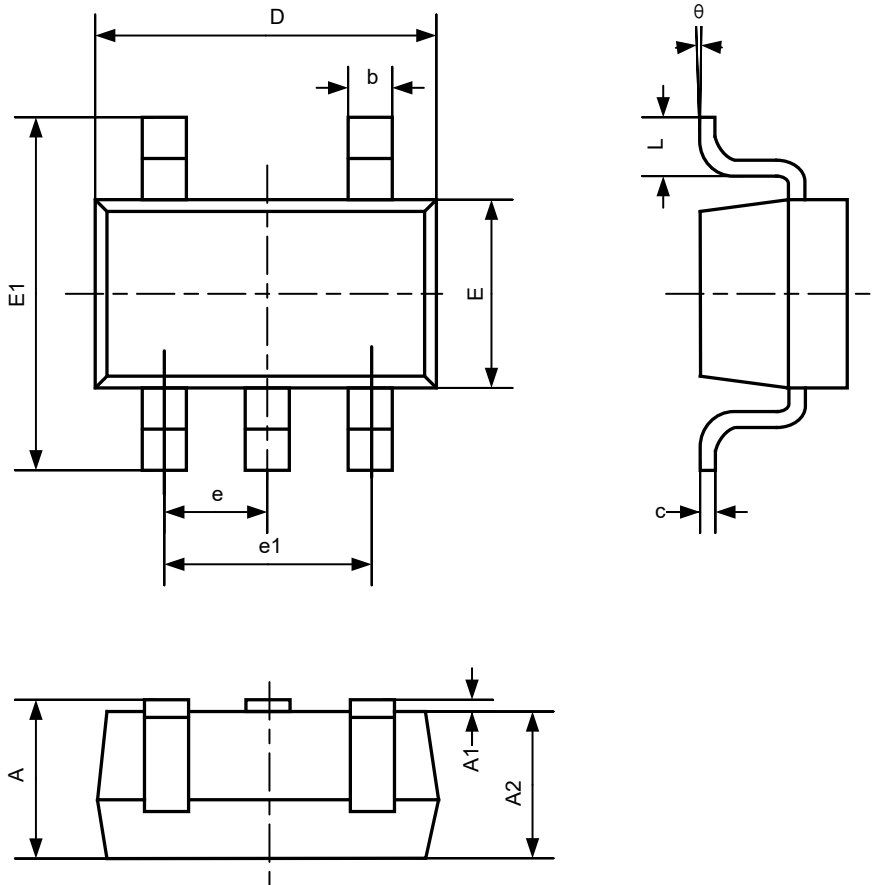

Symbol	Dimensions in Millimeters		Dimensions in Inches	
	Min	Max	Min	Max
A	0.900	1.100	0.035	0.043
A1	0.000	0.100	0.000	0.004
A2	0.900	1.000	0.035	0.039
b	0.150	0.350	0.006	0.014
c	0.080	0.150	0.003	0.006
D	2.000	2.200	0.079	0.087
E	1.150	1.350	0.045	0.053
E1	2.150	2.450	0.085	0.096
e	0.650 BSC		0.026 BSC	
e1	1.300 BSC		0.051 BSC	
L	0.260	0.460	0.010	0.018
θ	0°	8°	0°	8°

5 Revision History

Version	Date	Description
0.1	2022/10/31	Initial release
0.2	2023/04/19	Update some specification informations

Copyright and Important Notice

No part of this document shall be excerpted, translated, reproduced, transmitted, or disseminated by any organization, company, or individual in any form or by any means without the prior written consent of Nanjing Senasic Electronic Technology Co.,Ltd.

 and other SENASIC icons are trademarks of Nanjing Senasic Electronic Technology Co.,Ltd.(former Ningbo SENASIC Electronic Technology Co., Ltd.abbreviated as SENASIC).

The purchased products, services and features are stipulated by the contract made between SENASIC and the customer. All or part of the products, services and features described in this document may not be within the purchase scope or the usage scope. Unless otherwise specified in the contract, all statements, information, and recommendations in this document are provided "AS IS" without warranties, guarantees or representations of any kind, either express or implied.

The content of this document may be changed due to product version upgrades, adjustments, or other reasons.Unless otherwise agreed, this document is used as Use guide only, all statements, information, and recommendations in this document do not constitute a warranty of any kind, express or implied.

For further information on technical support, delivery and prices, please call the national consultation hotline: [021-5061-0206](tel:021-5061-0206), or you can obtain relevant support by email info@senasic.com.

Copyright © 2023 Nanjing Senasic Electronic Technology Co.,Ltd. All rights reserved.